

QUECTEL

QuecPython

Board For
BG95-XX

2328.

ADC0

GND

Zero

V1.3

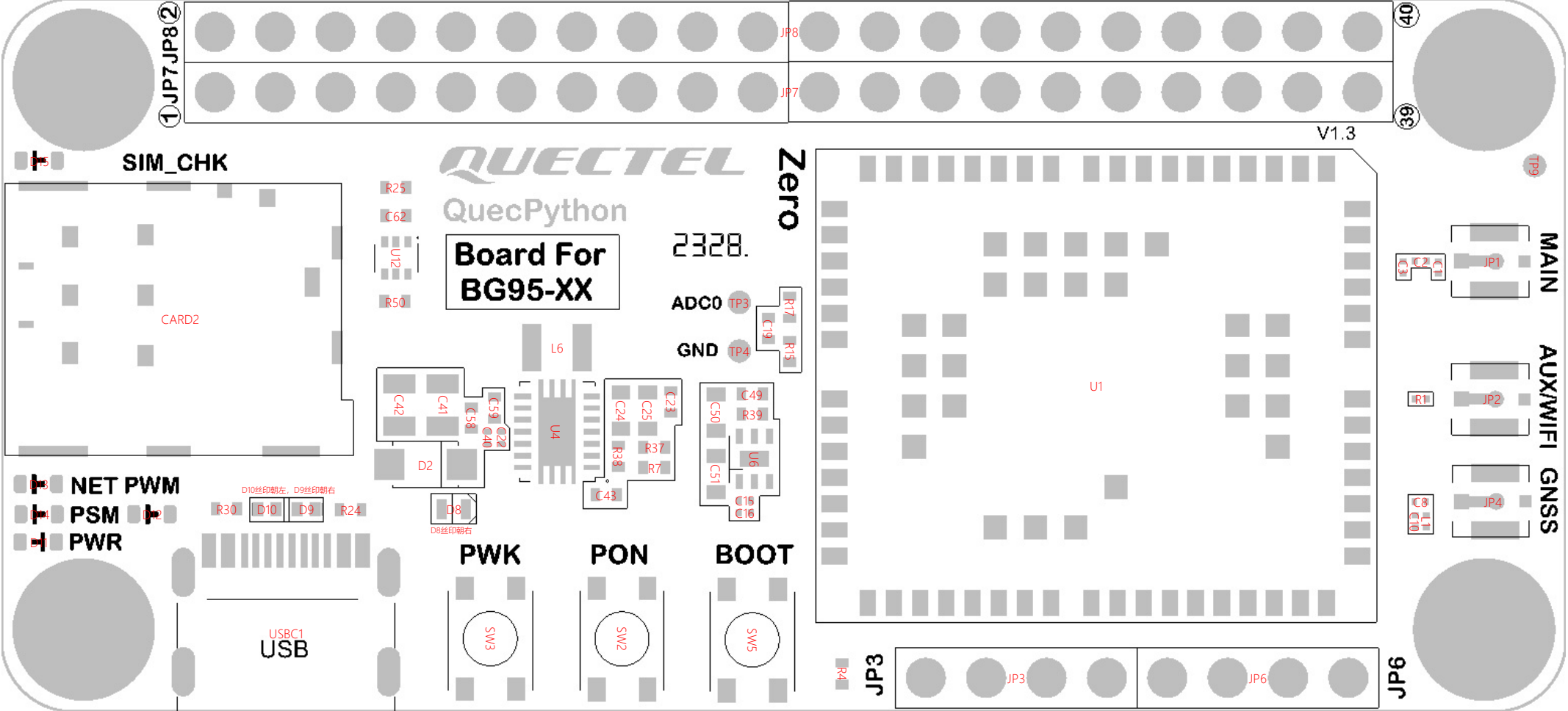

① JP7 JP8 ②

③ ④ ⑤ ⑥ ⑦ ⑧ ⑨ ⑩ ⑪ ⑫ ⑬ ⑭ ⑮ ⑯ ⑰ ⑱ ⑲ ⑳ ㉑ ㉒ ㉓ ㉔ ㉕ ㉖ ㉗ ㉘ ㉙ ㉚ ㉛ ㉜ ㉝ ㉞ ㉟ ㊱ ㊲ ㊳ ㊴ ㊵ ㊶ ㊷ ㊸ ㊹ ㊺ ㊻ ㊼ ㊽ ㊾ ㊿

SIM_CHK

CARD2

NET PWM

PSM

PWR

USBC1
USB

PWK

PON

BOOT

MAIN

AUX/WIFI

GNSS

JP3

JP6

TP9

JP1

JP2

JP4

JP8

JP7

R4

JP3

JP6

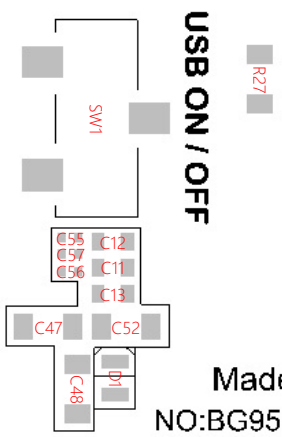
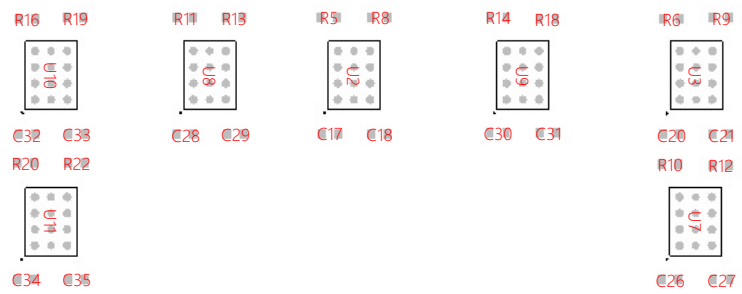
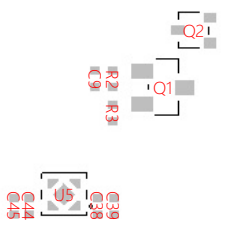
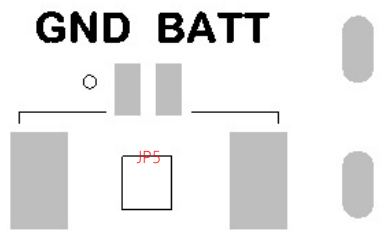
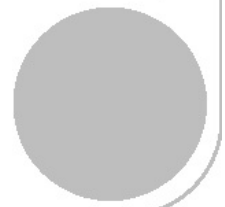
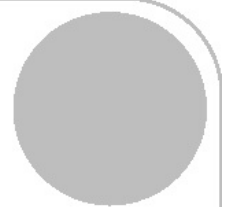
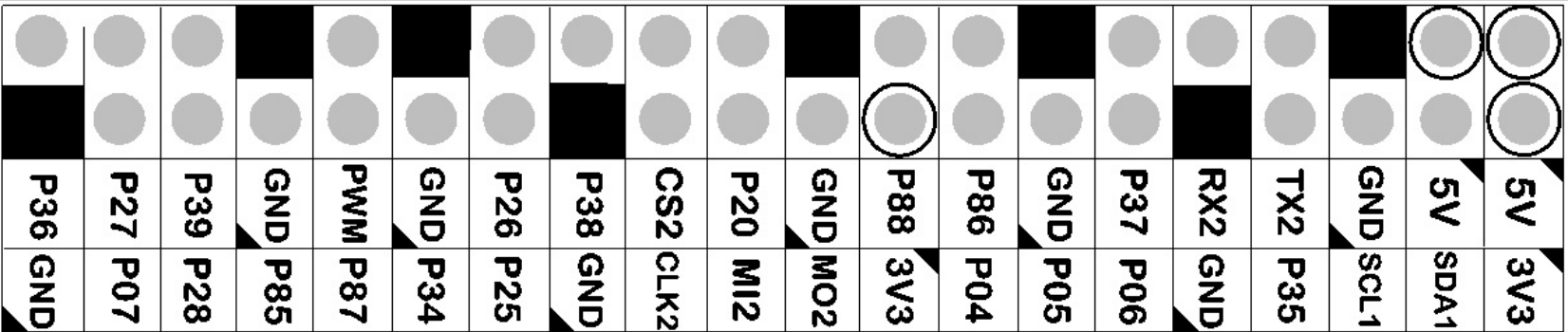

GNSS_EN	MODULE EN	VDD_EXT	PWK_AUTO

Made in China
NO:BG9520230801_0023

Powered by
QuecPython

TP8